



Energy gain of runaway electrons in vertical disruptions

J. Riemann^a, H. M. Smith^{a,b}, P. Helander^a

^a Max-Planck-Institut für Plasmaphysik, D-17491 Greifswald, Germany

^b Max-Planck-Institut für Sonnensystemforschung, D-37191 Katlenburg-Lindau, Germany

- introduction
- energy conversion - qualitative picture
- 2D model - setup and equations
- numerical results
- summary



Introduction (1)

- runaway electrons (REs):
 - electrons accelerated to relativistic speeds
 - energy gain exceeds energy loss
 - experience non-monotonic friction force $F(v)$
- RE formation mechanisms:
 - primary: Dreicer, hot-tail, γ (not discussed here)
 - secondary: avalanche for $E > E_c$ (important here)
 - E_c - critical field strength (required to maintain current of REs)
 - REs likely to be generated during tokamak disruptions
- REs are a possible threat to future tokamaks:
 - strongly localized beams with high energies (\sim MeV)
 - deep penetration of materials (\sim cm)
 - more REs for large devices expected ($G_{RE} \sim \exp 2.5 I_P(\text{MA})$)

investigation of REs on Tore Supra:

- “slowing-down of REs takes time ... ”
- active current and position control
- RE plateaus controlled for some seconds
- massive gas injection applied
- part of disruption mitigation strategy
- sudden RE current collapses observed

F. Saint-Laurent et al.

Control of runaway electron heat loads on Tore Supra
38th EPS conference, Strasbourg (2011)

60 kA runaway electron beam striking CFC wall in Tore Supra

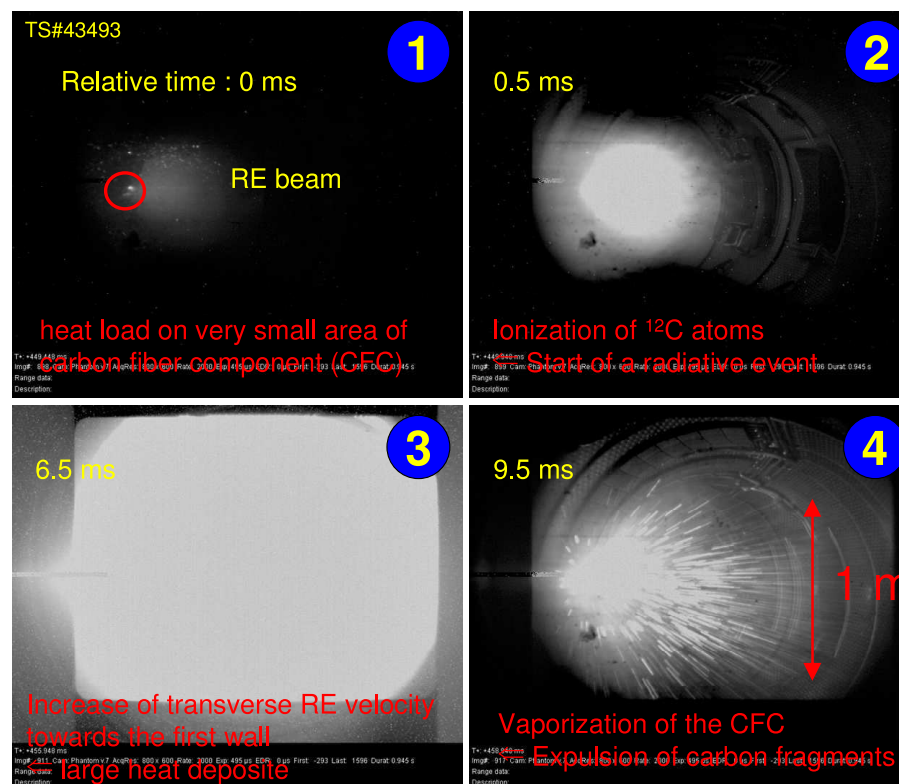

courtesy of F. Saint-Laurent



Introduction (2)

- **theoretical & experimental studies**
 - RE formation and properties
 - energy conversion by REs (*Putvinski et al., Loarte et al.*)
 - RE loss mechanisms
- **strategies for RE suppression or mitigation wanted**
 - collisional slowing down (killer-pellets, massive gas injection, ...)
 - drift orbit losses through RMPs \implies *G. Papp (O-26)*
 - RE current control (*Saint-Laurent et al.*)
- **RE control closely connected to disruption control**

\implies **REs will be an important issue for ITER operation!**



Possible Conditions after Current Quench in ITER

- **population of REs with ~ 10 MeV**
- **current conversion of up to $\sim 2/3 I_P^0$ possible**
 - **initial RE current $I_{RE} \sim 10$ MA**
 - **initial RE density $n_{RE} \sim 10^{16} \text{ m}^{-3}$ ($N_{RE} \sim 10^{19}$)**
- **background plasma with $T \sim 5$ eV**
 - **determines free electron density $n_e \sim 10^{21} \text{ m}^{-3}$**
 - **no significant contribution to current (high resistivity)**
- **initial kinetic energy of REs $W_{RE}^0 \sim 20$ MJ**
 - **small compared to magnetic field energy!**

$$\frac{W_{RE}^0}{W_m^{pol}} \sim \frac{(\gamma - 1)I_A}{I_P^0} \sim 0.03$$

- **instabilities causing the plasma to move toward the wall**



Energy Conversion - Qualitative Picture

what will happen:

- **plasma drifts toward walls and induces eddy currents**
- **back reaction on plasma controls motion**
- **plasma hits wall and is getting scraped off**
- **rapid current loss causes strong toroidal fields driving REs**
- **amplification of REs at cost of poloidal field energy**
- **energy of poloidal field dissipated in plasma and walls**



Energy Conversion in Fusion Plasmas with REs

- *Putvinski et al., Plas. Phys. Contr. Fusion* **39** (1997)
 - poloidal magnetic field is reservoir of free energy
 - strong amplification of RE energy during vertical drift possible
 - 1D model for straight plasma cylinder enclosed by cylindrical wall
 - highest RE wall loads predicted for slow disruptions
- *Loarte et al., Nucl. Fusion* **51** 073004 (2011)
 - experimental evidence for RE energy conversion on JET
 - 1D numerical simulation results
- next step: 2D modelling (axisymmetric)
 - plasma with circular cross section
 - self-consistent vertical motion of plasma
 - resistive diffusion in conducting structures external to plasma

2D Computational Model Setup

Model assumptions:

- I_P^0 carried by REs exclusively
- circular plasma cross section
- large aspect ratio
- up-down symmetric objects
- up-down symmetric PF1 coil current ($\uparrow\uparrow I_P$)
- no other PF coil/CSO currents applied
- vertical motion only (plasma rest frame)

Numerics:

- FV ansatz and Newton's method
- $\psi = 0$ at $R = \varepsilon$, $\nabla\psi \cdot dS = 0$ elsewhere
- non-equidistant grid (finest at plasma center)

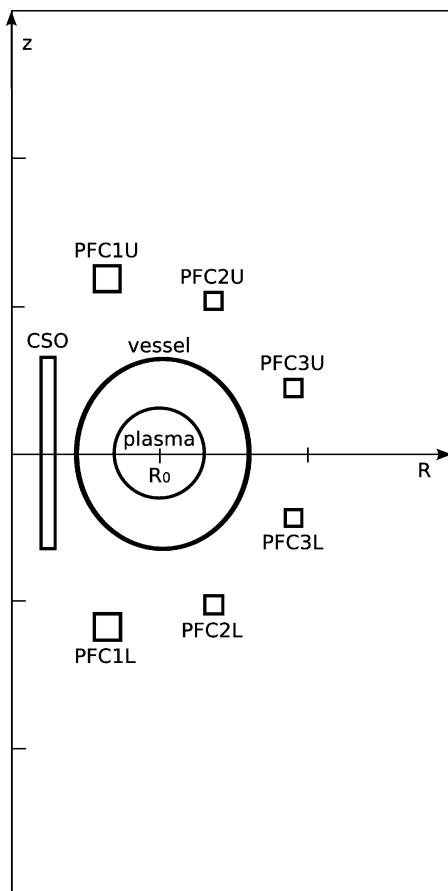

domain with objects



2D-Mathematical Model

- magnetic field in axisymmetric geometry

$$\mathbf{B} = I(\psi, t) \nabla \varphi + \nabla \varphi \times \nabla \psi$$

$\psi(R, z, t) \sim$ poloidal magnetic flux

- toroidal current density (runaway + Ohmic)

$$J_\varphi = J_r + \sigma E_\varphi = \frac{\Delta^* \psi}{\mu_0 R} \quad \left(\Delta^* = R \frac{\partial}{\partial R} \frac{1}{R} \frac{\partial}{\partial R} \right)$$

- Grad-Shafranov-like equation in plasma and external conductors

$$\sigma \mu_0 \frac{\partial \psi}{\partial t} = \Delta^* \psi - \mu_0 R J_r - \underbrace{\sigma \mu_0 v_z \frac{\partial \psi}{\partial z}}_{\text{objects moving with } v_z}$$

solve for time evolution of poloidal magnetic field!



Evolution of Runaway Current

$$\frac{1}{J_r} \frac{\partial J_r}{\partial t} \simeq \left(\frac{\langle E_\varphi \rangle}{E_c} - 1 \right) \left(\frac{\Theta(\langle E_\varphi \rangle - E_c)}{\tau_a} + \frac{\Theta(E_c - \langle E_\varphi \rangle)}{\tau_d} \right)$$

E_c - critical field strength

- **exponential growth for $\langle E_\varphi \rangle > E_c$ by avalanche**
unconventional Ohm's law with avalanche time

$$\tau_a = \tau \ln \Lambda \sqrt{\frac{3(Z_{\text{eff}} + 5)}{\pi \gamma(\epsilon)} \left(1 - \frac{E_c}{E} + \frac{4\pi(Z_{\text{eff}} + 1)^2}{3\gamma(\epsilon)(Z_{\text{eff}} + 5)(E^2/E_c^2 + 4/\gamma^2(\epsilon) - 1)} \right)^{1/2}}$$

$$\gamma = (1 + 1.46\sqrt{\epsilon} + 1.72\epsilon)^{-1}, \quad \epsilon = r/R, \quad \tau_a \text{ for } E \gg E_c$$

- **exponential decay for $\langle E_\varphi \rangle < E_c$ by collisional damping**
 $\tau_d = 2\tau \ln \Lambda$ - electron collisional damping time
- **radiation losses unimportant on time scales encountered here**



Self-Consistent Motion of Plasma

- plasma inertia is very small \implies vertical force on plasma should vanish!

$$F_z = \int_{V_{\text{plas}}} (\mathbf{J} \times \mathbf{B}) \cdot \nabla z \, dV \stackrel{!}{=} 0$$

- with $\mathbf{J} = \mathbf{J}^{\text{in}} + \mathbf{J}^{\text{ex}}$ and $\mathbf{B} = \mathbf{B}^{\text{in}} + \mathbf{B}^{\text{ex}}$ there is (for large aspect ratio):

$$F_z = \int_{V_{\text{plas}}} (J_R^{\text{in}} B_\varphi^{\text{ex}} - J_\varphi^{\text{in}} B_R^{\text{ex}}) \, dV \simeq - \int_{V_{\text{plas}}} J_\varphi^{\text{in}} B_R^{\text{ex}} \, dV + O(\epsilon J_R^{\text{in}} B_\varphi^{\text{ex}})$$

- iterative procedure to determine v_z for time step Δt :

move plasma as to obey condition $F_z(t + \Delta t) = 0$!

Energy Transfer to Runaway Electrons

- **total energy transferred to plasma** (background and runaway electrons)

$$W_{\text{plas}} = \int_0^t dt' \int_{V_{\text{plas}}} J_{\varphi} E_{\varphi} dV = \int_0^t dt' \int_{V_{\text{plas}}} (\sigma E_{\varphi} + J_r) E_{\varphi} dV = W_{\Omega} + W_r$$

- **energy lost by REs through collisional slowing-down on background**

$$W_{E_c} \approx \int_0^t dt' \int_{V_{\text{plas}}} J_r E_c dV$$

- **final kinetic RE energy** (... which is going to strike the first wall!)

$$W_{\text{RE}} = W_{\text{RE}}^0 + \int_0^t dt' \int_{V_{\text{plas}}} J_r (E_{\varphi} - E_c) dV = W_{\text{RE}}^0 + W_r - W_{E_c}$$

Numerical Results - Plasma Motion

A reference case

$$I_P^0 = 10 \text{ MA (flat profile)}$$

$$T \simeq 5 \text{ eV}$$

$$n \simeq 10^{21} \text{ m}^{-3}$$

$$I_{PF1} = 0.84 I_P^0$$

A* I_P^0 with peaked profile

B $I_{PF1} = 1.25 I_P^0$

- initial displacement $\delta z = .25 \text{ m}$
- free-motion phase $z < 2.1 \text{ m}$
- plasma hits wall at $z = 2.1 \text{ m}$
- scrape-off phase $z > 2.1 \text{ m}$
- plasma depleted at $z = 4.1 \text{ m}$

vertical position of plasma center $z(t)$

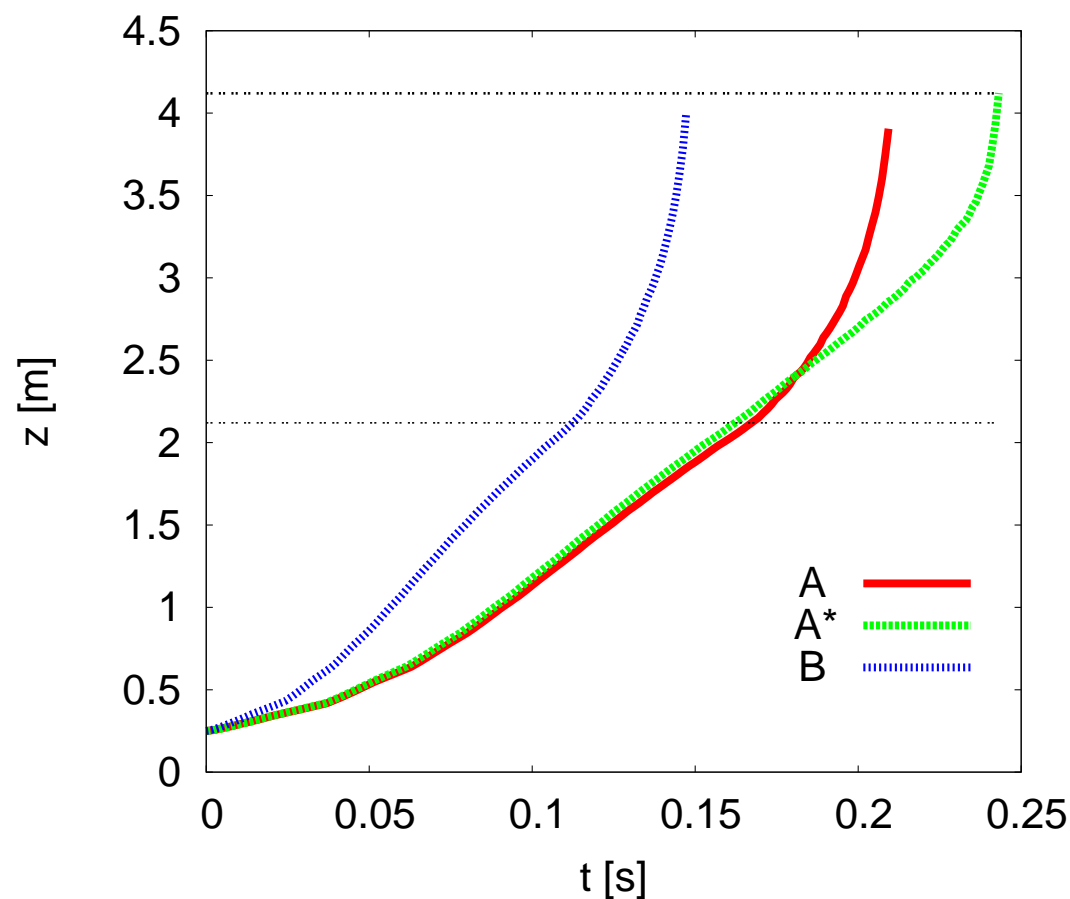

Numerical Results - RE Energy Gain vs. Time

A reference case

$$I_p^0 = 10 \text{ MA (flat profile)}$$

$$T \simeq 5 \text{ eV}$$

$$n \simeq 10^{21} \text{ m}^{-3}$$

$$I_{PF1} = 0.84 I_p^0$$

A* I_p^0 with peaked profile

B $I_{PF1} = 1.25 I_p^0$

- growth in scrape-off phase
- $W_{RE}^0 \sim 20 \text{ MJ}$
- total $W_{RE} \sim 100 \text{ MJ}$ possible
- final values identical

kinetic energy gained by REs ($W_{RE} - W_{RE}^0$) vs. t

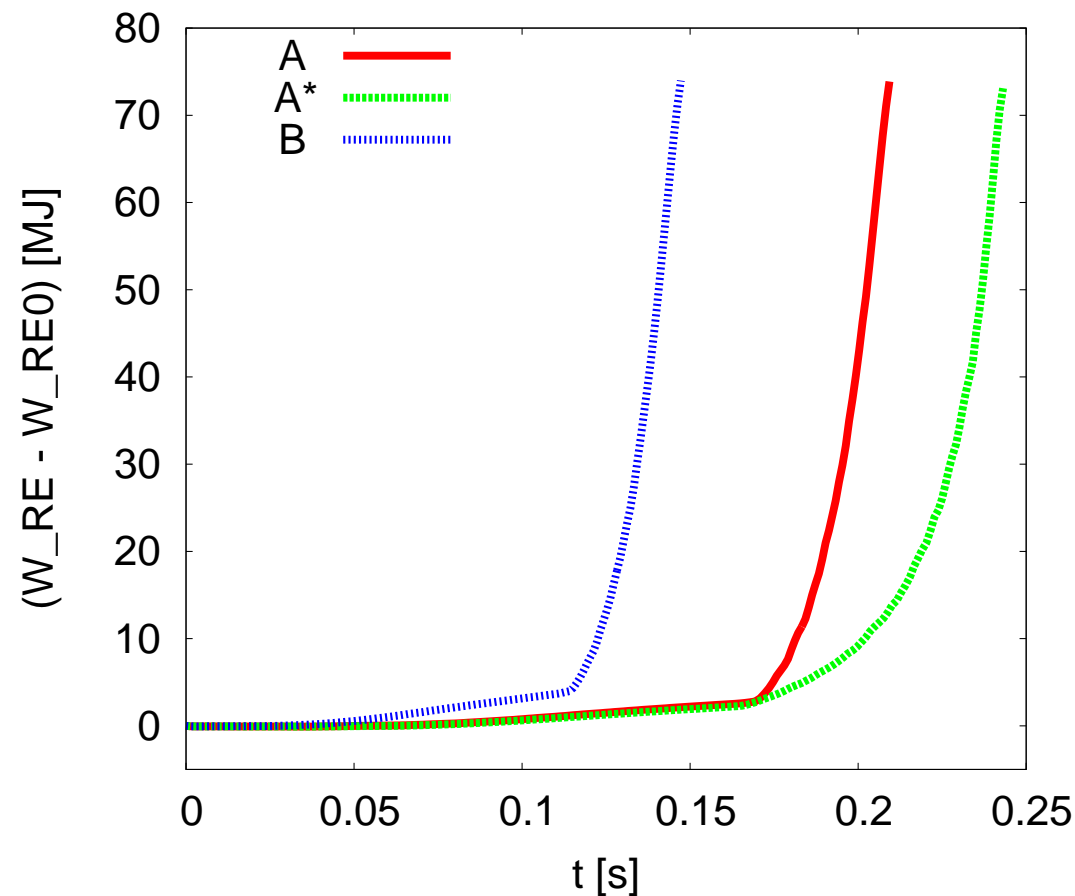

Numerical Results - RE Energy Gain vs. Position

A reference case

$$I_p^0 = 10 \text{ MA (flat profile)}$$

$$T \simeq 5 \text{ eV}$$

$$n \simeq 10^{21} \text{ m}^{-3}$$

$$I_{PF1} = 0.84 I_p^0$$

A* I_p^0 with peaked profile

B $I_{PF1} = 1.25 I_p^0$

- growth in scrape-off phase
- $W_{RE}^0 \sim 20 \text{ MJ}$
- total $W_{RE} \sim 100 \text{ MJ}$ possible
- final values identical

kinetic energy gained by REs ($W_{RE} - W_{RE}^0$) vs. z

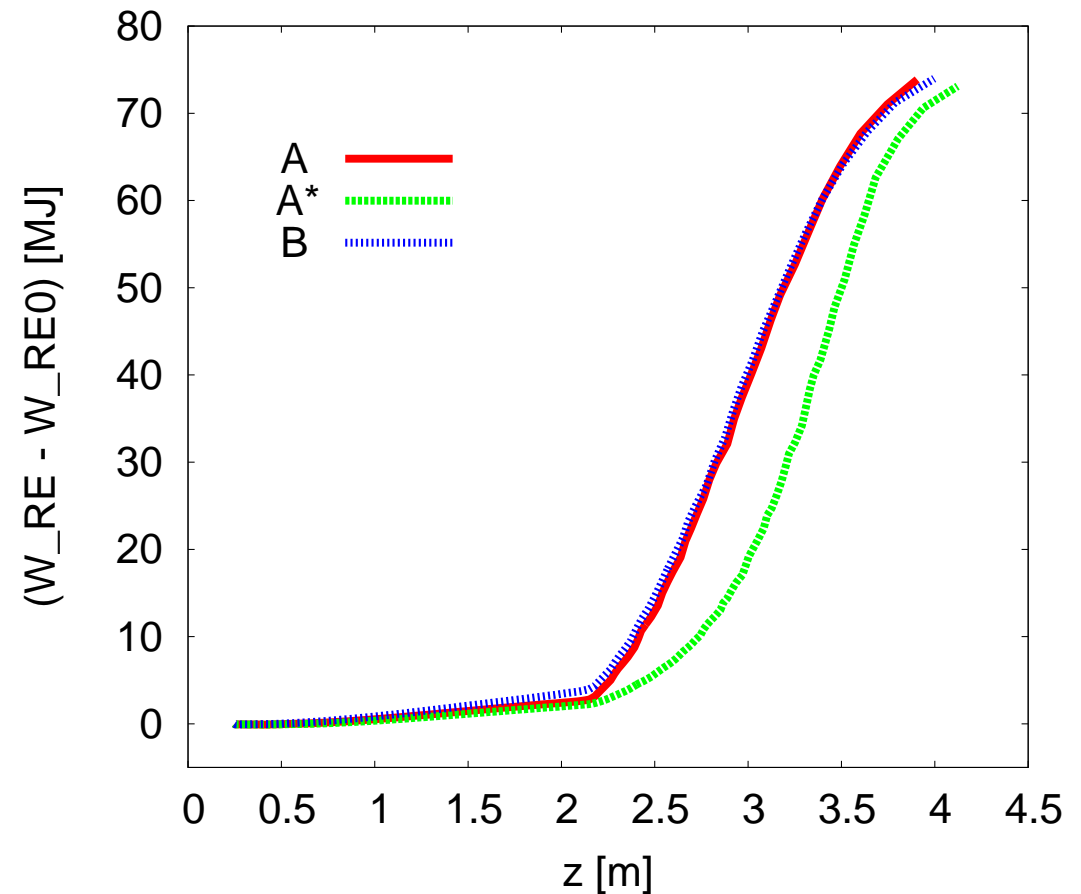

Energy Conversion in Fusion Plasmas with REs

- *Putvinski et al., Plas. Phys. Contr. Fusion 39 (1997)*
 \implies **highest RE wall loads predicted for slow disruptions**
- **supported by simple 2-circuit model:**

let currents be:

$$I_1 = I_0 e^{-t/t_0} \quad (\text{plasma}) \quad \text{and} \quad I_2(t=0) = 0 \quad (\text{wall})$$

voltages then:

$$U_1 = -L_1 \dot{I}_1 - M \dot{I}_2$$

$$U_2 = R_2 I_2 = -L_2 \dot{I}_2 - M \dot{I}_1$$

dissipated energies:

$$W_1 = \left(L_1 - \frac{M^2}{(R_2 t_0 + L_2)} \right) \frac{I_0^2}{2} \quad W_2 = \frac{M^2}{(R_2 t_0 + L_2)} \frac{I_0^2}{2}$$

$$\omega t_0 = R_2 / L_2 t_0 \gg 1 \quad \implies \quad W_1 \approx W_1 + W_2 = \frac{L_1 I_0^2}{2}$$

- **energy gain for cases A and B found identical \implies contradiction?**

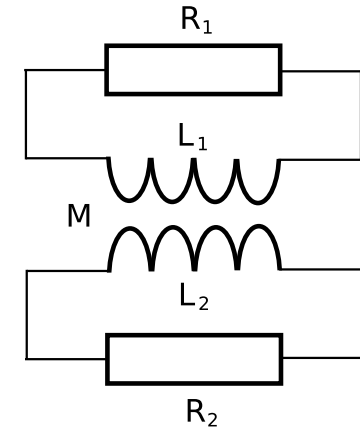

Numerical Results - Energy Contributions

A reference case

$$I_P^0 = 10 \text{ MA (flat profile)}$$

$$T \simeq 5 \text{ eV}$$

$$n \simeq 10^{21} \text{ m}^{-3}$$

$$I_{PF1} = 0.84 I_P^0$$

B $I_{PF1} = 1.25 I_P^0$

- total energy transfer $W_{\text{plas}} \sim t$
- friction (W_{E_c}) not negligible!
- ΔW_{RE} identical for A and B
- in free motion $W_{\text{plas}} \sim W_{E_c}$
- implications for E_φ ?

energies W_{plas} , W_r and W_{E_c} vs. t

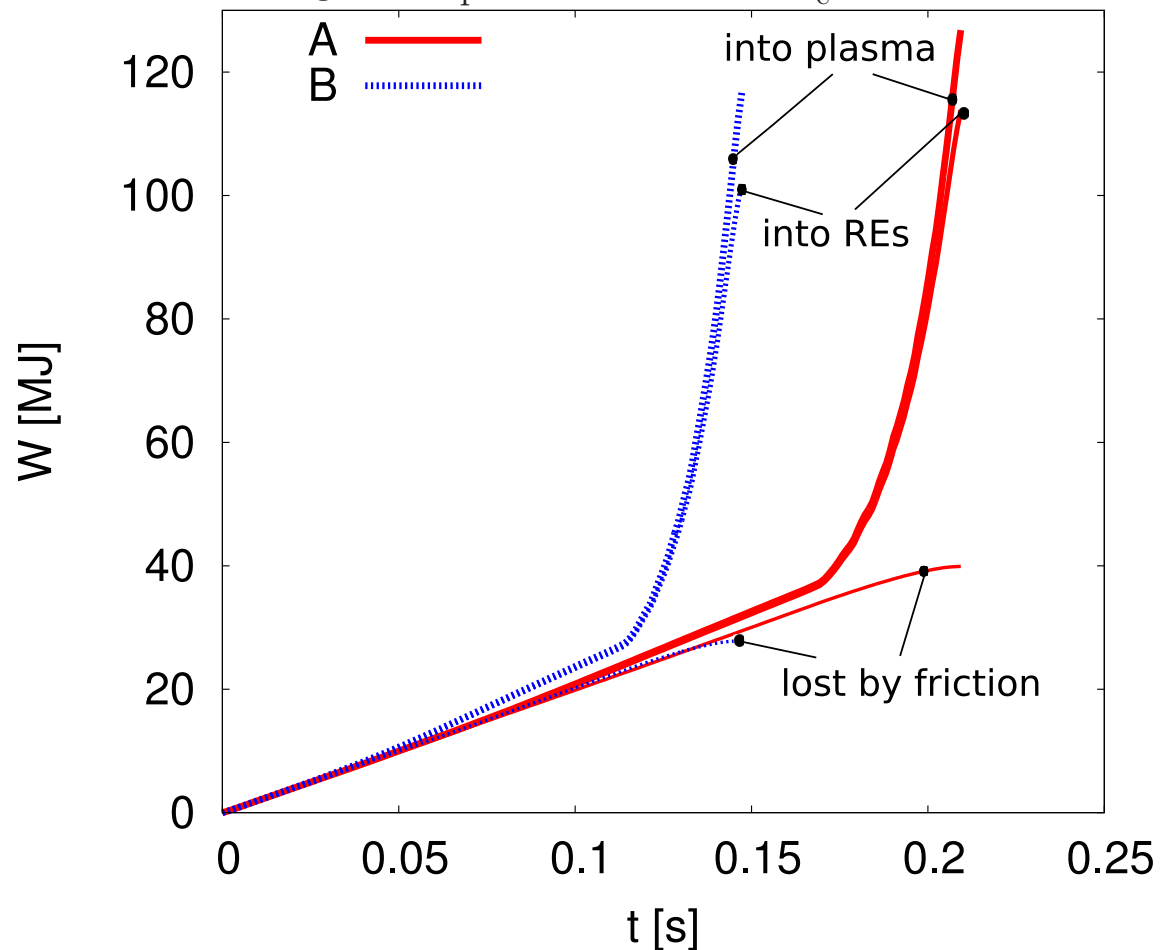

Numerical Results - Electric Field Strength

- reference case

$I_p^0 = 10 \text{ MA}$ (flat profile)

$T \simeq 5 \text{ eV}$

$n \simeq 10^{21} \text{ m}^{-3}$

$I_{PF1} = 0.84 I_p^0$

plasma hits wall at $t = t^*$

- free-motion phase ($t < t^*$):

- motion makes $\langle E_\varphi \rangle \approx E_c$

- scrape-off phase ($t > t^*$):

- $\langle E_\varphi \rangle \gg E_c$ at edge \Rightarrow REs!

- $\langle E_\varphi \rangle \approx E_c$ in center

- shrinking plasma radius

electric field strength $\langle E_\varphi \rangle / E_c$ vs. (ρ/a)

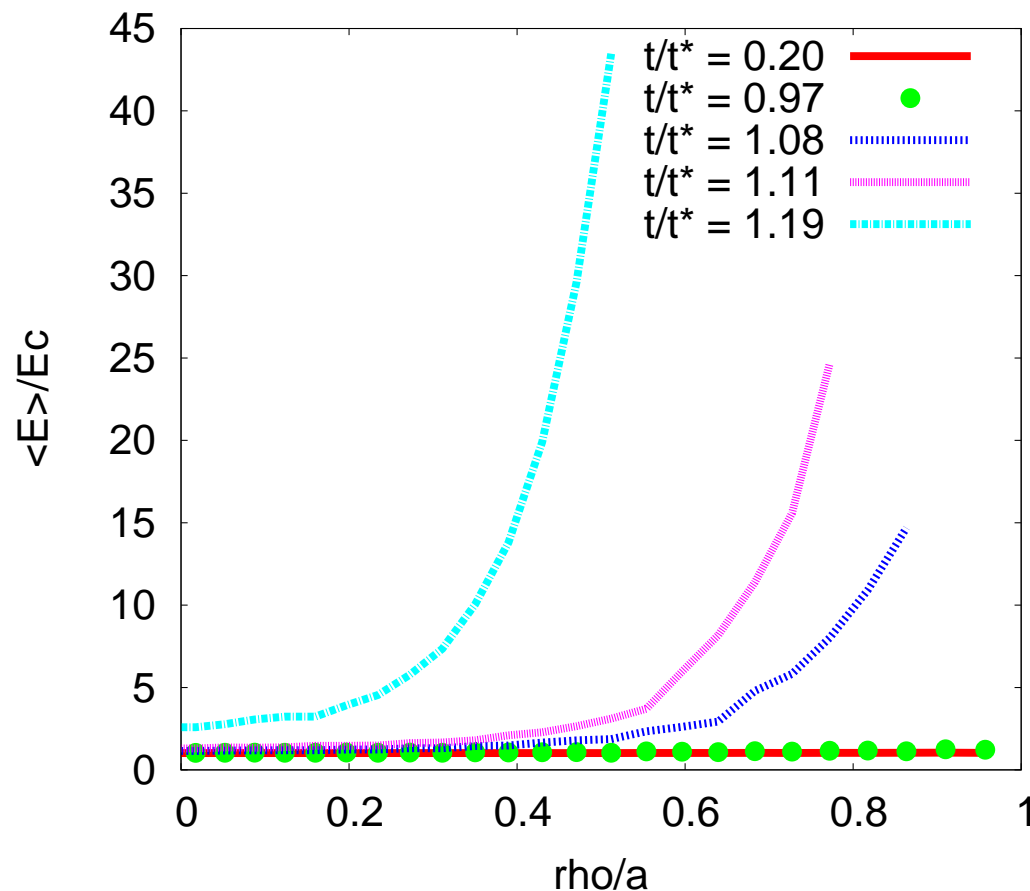



Electric Field Strength Estimate

$\langle E_\varphi \rangle \approx E_c$ in most of the plasma is characteristic feature!

- there must be (displacement current neglected):

$$\nabla^2 E = \mu_0 \frac{\partial J_\varphi}{\partial t} \quad \text{with} \quad J_\varphi = J_r \quad \text{and} \quad \frac{\partial J_r}{\partial t} \simeq \frac{J_r}{\tau_a} \left(\frac{E}{E_c} - 1 \right)$$

- if $J_\varphi = J_r$ with $\partial J_r / \partial t \simeq J_r \left(\frac{E}{E_c} - 1 \right) / \tau_a$
- then:

$$a^2 \nabla^2 E = \frac{a^2 \mu_0 J_r}{\tau_a E_c} (E - E_c)$$

- estimate r.h.s.:

$$\frac{a^2 \mu_0 J_r}{\tau_a E_c} (E - E_c) \sim \frac{\mu_0 I_r}{\pi \tau_a E_c} (E - E_c) \approx \frac{I_r}{0.2 \text{ MA}} (E - E_c)$$

- since $I_r \gg 0.2 \text{ MA}$ there follows $E \approx E_c$ or $(a^2 \nabla^2 E) / E \gg 1$ (plasma edge)

\implies use full expression for τ_a !



Numerical Results - Current Density

- reference case

$I_p^0 = 10 \text{ MA}$ (flat profile)

$T \simeq 5 \text{ eV}$

$n \simeq 10^{21} \text{ m}^{-3}$

$I_{PF1} = 0.84 I_p^0$

plasma hits wall at $t = t^*$

- RE amplification at edge

- hollow current profile

- skin depth $\lambda \sim 0.1 a$ (Putvinski)

RE current density J_r/J_0 vs. (ρ/a)

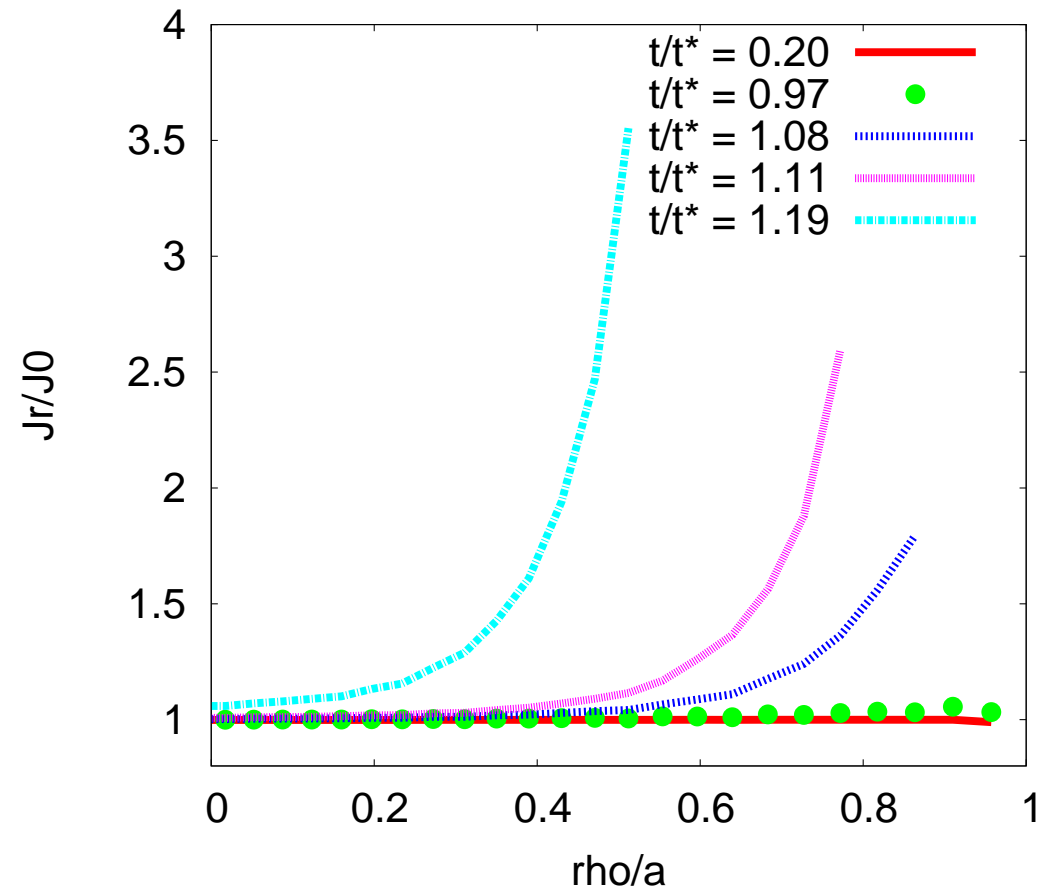

Numerical Results - Parameter Dependence

A reference case

$$I_p^0 = 10 \text{ MA (flat profile)}$$

$$T \simeq 5 \text{ eV}$$

$$n \simeq 10^{21} \text{ m}^{-3}$$

$$I_{PF1} = 0.84 I_p^0$$

C $T^C = 2T^A$

$\Rightarrow \tau_{\text{skin}}^{\text{plas}}$ larger

D $n^D = 2n^A$

$\Rightarrow E_c$ higher

E $\sigma_{\text{wall}}^E = 2\sigma_{\text{wall}}^A$

$\Rightarrow \tau_{\text{wall}}$ larger

\Rightarrow longer duration

small differences in ΔW_{RE} found!

parameter dependence of RE energy gain

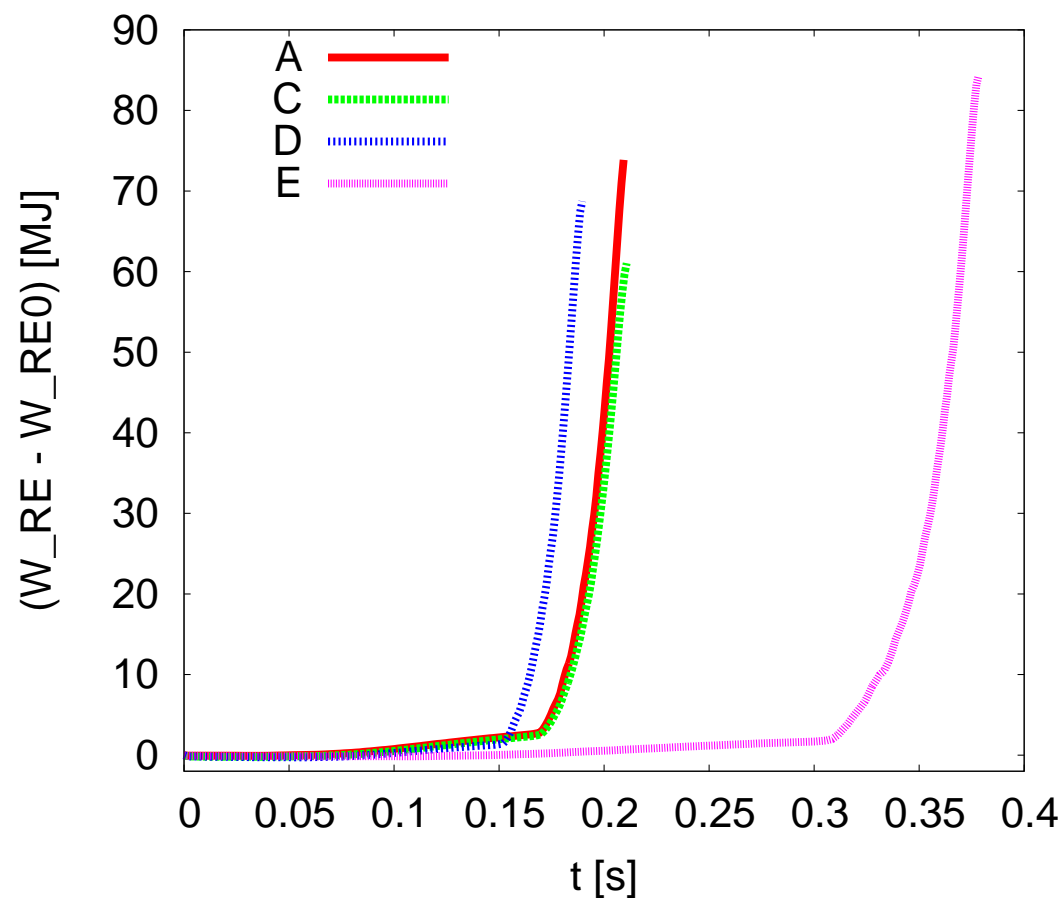

Numerical Results - Scrape-off Loss Power

A reference case

$$I_P^0 = 10 \text{ MA (flat profile)}$$

$$T \simeq 5 \text{ eV}$$

$$n \simeq 10^{21} \text{ m}^{-3}$$

$$I_{PF1} = 0.84 I_P^0$$

$$P \approx (2\pi)^2 R_0 \varrho n_r^{\text{edge}} v_z (mc^2 \ln \Lambda)$$

- onset with scrape-off phase
- strong peak (... can be worse!)
- size of wall fragment?
- severe damage to walls!

no material can withstand GW/m^2

scrape-off loss power $P(t)$

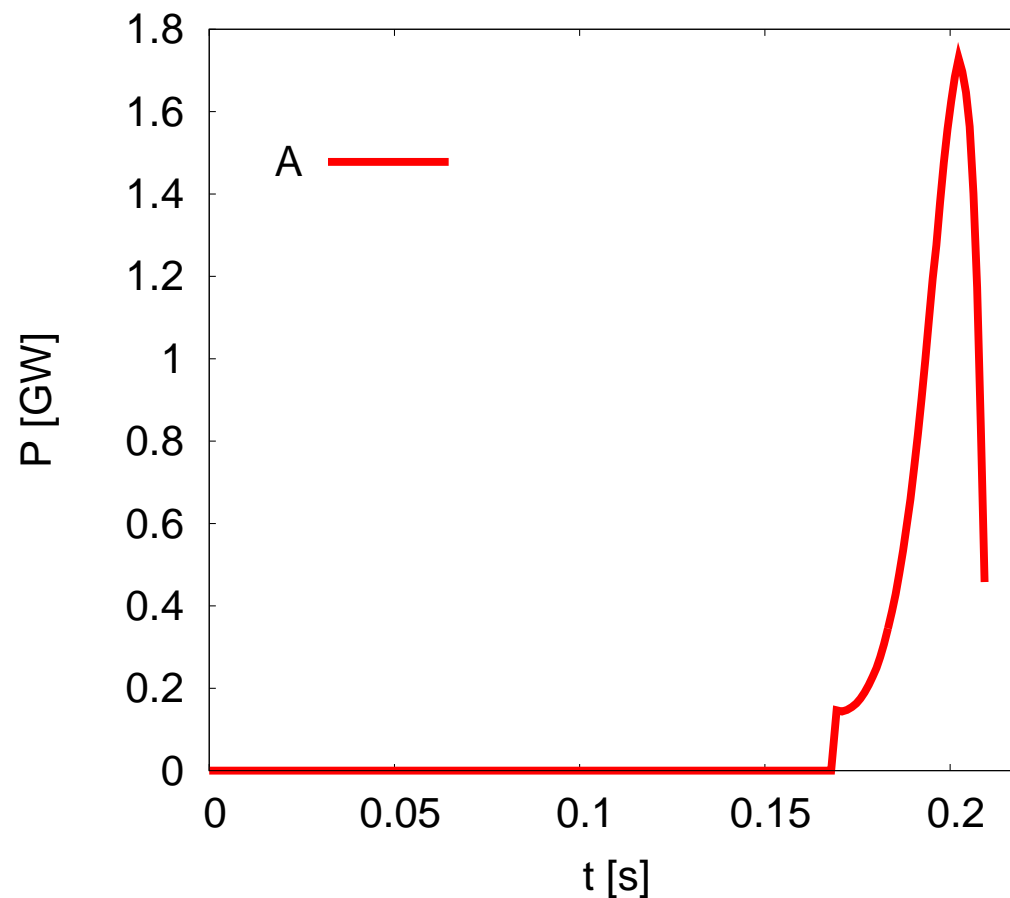



Summary

- 2D model for energy conversion under disruption presented
- earlier qualitative results by other authors confirmed
- substantial conversion of magnetic energy during disruptions
- final RE energies of up to ~ 100 MJ possible
- two qualitatively different phases of plasma motion found
- energy mainly consumed by friction in free-motion phase
- strong energy gain by REs during scrape-off phase

RE suppression/control/mitigation is a key topic for ITER!

(submitted to *Physics of Plasmas*)